

# MAQUET

## MOBILE OPERATING TABLE ALPHASTAR

SURGICAL WORKPLACES





## FLEXIBLE FROM HEAD TO FOOT – THE ALPHASTAR MOBILE OPERATING TABLE MAQUET – THE GOLD STANDARD



**Form and function based on experience:** As the world's market leader, MAQUET is fully aware of the high expectations for operating tables. Close co-operation with physicians, surgeons and nursing staff is the basis for products optimized for the needs of practice, products which simplify day-to-day work in the operating room and help to enhance patient safety and comfort.

**Proven in thousands of applications:** The ALPHASTAR with electrically controlled hydraulic drive for all the table's essential functions – from table top positioning and autodrive to reverse mode. ALPHASTAR can be modified to suit the needs of any surgical discipline in just a few quick steps – ideal for smooth workflow in the operating room.

MAQUET – The Gold Standard.

## FLEXIBLE AND ABLE TO WITHSTAND EVEN EXTREME LOADS ALPHASTAR: MAXIMUM PERFORMANCE IN FOUR VERSIONS

**As flexible as it is reliable:** Easy manoeuvring using the hand control is just one example of the many convenience features found in the ALPHASTAR; another is the reverse mode used when patients are reversed, head to foot, on the table. With its precisely adjustable table tops and special modules for versatility in use, the ALPHASTAR can be set up for any general surgical discipline with just a few quick actions.

**One name, four versions:** Three additional versions, in addition to the standard model, have been developed to respond to special requirements. With maximum capacity for 450 kg of patient weight, the ALPHASTAR PLUS is well prepared to handle extreme situations. The ALPHASTAR in its low-height version is highly convincing, since it can be lowered to just 598 mm, ideal for surgery while seated. The ALPHASTAR TOP was developed especially to take account of the needs of ophthalmology, maxillo-facial surgery and ENT use.

*Electric autodrive in the base with gentle starting and safety braking functions (optional in the standard and low-height versions)*

*Maximum permissible patient weight for the ALPHASTAR PLUS: 450 kg*

*Ergonomic working positions, seated or standing, thanks to flexible height adjustment*

*Modular design for ideal adaptation to a wide variety of surgical tasks*

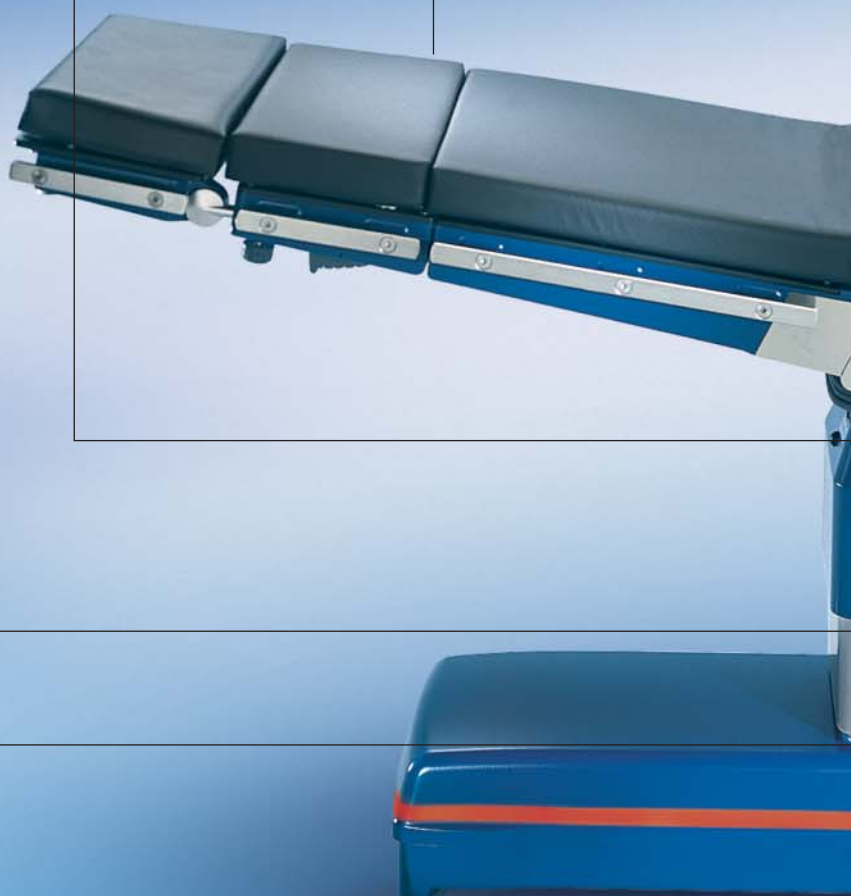



ALPHASTAR: Proven thousand of times over in the operating room



ALPHASTAR in the low-height version: adjustable from 598 to 950 mm in height



ALPHASTAR TOP with the patented "anatomy arm" for perfect support of the cervical spine in every phase of every movement. Additional information on page 12

Short reverse back plate for many additional positioning possibilities

Expanded modularity: Mounting point for socket-mounted modules

Modular design for ideal adaptation to a wide variety of surgical tasks



## ANATOMICALLY CORRECT PATIENT POSITIONING EXAMPLE: GYNAECOLOGY



*The short "reverse" back plate can be lowered down, making it possible to set the ideal working height for the surgeon.*

*The integrated combination of leg plates and knee crutches offers simple, anatomically correct patient positioning for gynaecological, urological, rectal and MIS procedures.*





## FREEDOM OF MOVEMENT FOR THE IMAGE INTENSIFIER EXAMPLE: UROLOGY AND VASCULAR SURGERY

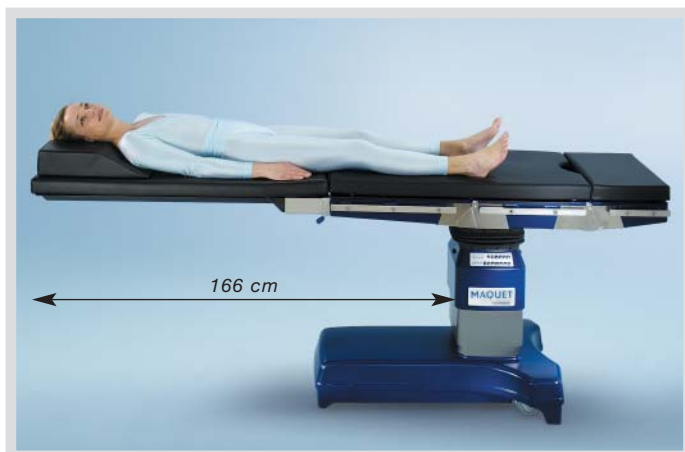

*ALPHASTAR with the seat plate extension (TUR drainage set optional). Recommended: the direct placement stirrups with one-hand operation to facilitate putting the patient in the desired position (also possible during a procedure beneath sterile drapes). Great leeway for using the image intensifier across the entire urogenital tract.*

*Vascular surgery or use of a catheter: X-ray examination of the inguinal region and upwards using the carbon-fibre back plate.*

## FREEDOM OF ACCESS AND UNIMPEDED IMAGE INTENSIFIER USE EXAMPLE: ORTHOPAEDICS



*Putting the patient in the prone position permits unrestricted access for the C-arm in orthograde X-ray examinations of the affected vertebrae.*



*The carbon-fibre module permits unrestricted C-arm access through 360° for examining the lower extremities and pelvis.*







## MODULAR DESIGN FOR VARYING REQUIREMENTS EXAMPLE: TRAUMATOLOGY



*The module specially designed for procedures at the shoulder ensures direct and unrestricted access to the surgical area and eliminates any hindrance of the C-arm. The two side sections in this three-part plate can be removed and, moreover, the head support can be swung to the left and right.*



*The extension device makes for stable positioning of the injured lower extremities while applying longitudinal traction. It facilitates work by the surgical team and the use of the C-arm. Thanks to simplicity in assembling the traction accessories, any required position can be set up quickly and safely by just a single nurse.*

## UNIVERSAL IN APPLICATION MATCHES EVERY OR SITUATION PERFECTLY



*Gall bladder: Raising the operating field is easy using the Flex function, with the patient oriented in either direction.*



*Cholecystectomy, MIS procedure: Stabilizing and positioning the patient with the use of the Maquetmatic accessory provides ready access to the operating field.*



*Rectal: Position with the patient kneeling for rectal procedures, using the rectal positioning device and the specially designed prone head rest.*





**WITH MANY CONVENIENT DETAILS  
FOR BOTH THE PATIENT AND THE STAFF**



*Kidneys: Segmented pads make for stable positioning and provide abdominal freedom for percutaneous lithotomies, no matter how tall the patient might be.*

*Neurosurgery (large illustration): Patient seated for procedures at the head, with extension plate for taller patients.*



*Ophthalmology: The horseshoe-shaped head rest with its three joints makes for flexible positioning of the head. The adjustable height of the ALPHASTAR low-height version, down to as little as 598 mm, and generous legroom reduce strain when working in a sitting position.*

## ALPHASTAR TOP THE RIGHT INNOVATION FOR MAXILLO-FACIAL, OPHTHALMOLOGY AND ENT PROCEDURES

**Perfect support during the operation:** ALPHASTAR TOP was developed especially for maxillo-facial, ophthalmology and ENT procedures. An entirely new concept in head support ensures that the spinal column will be supported correctly during every phase of movement. At the same time the low table heights (of from 600 to 950 mm) and generous leg-room provide the best working environment for the surgeon.



*Motor-powered head positioning with the patented "anatomy arm"*





## WHERE TECHNOLOGY FOLLOWS NATURE PERFECT HEAD POSITIONING WITH THE “ANATOMY ARM”

**The perfect curve:** Earlier positioning devices moved the head along a simple arc of a circle, which did not correspond to human anatomy. With its patented “anatomy arm” the ALPHASTAR TOP moves the horseshoe-shaped head rest along a more natural line of motion (red line in the illustration). Electric motor power makes for particularly gentle positioning of the head. The result is anatomically correct positioning in every phase of treatment. Compression and extension of the cervical spine (white arrows) are avoided in this way.

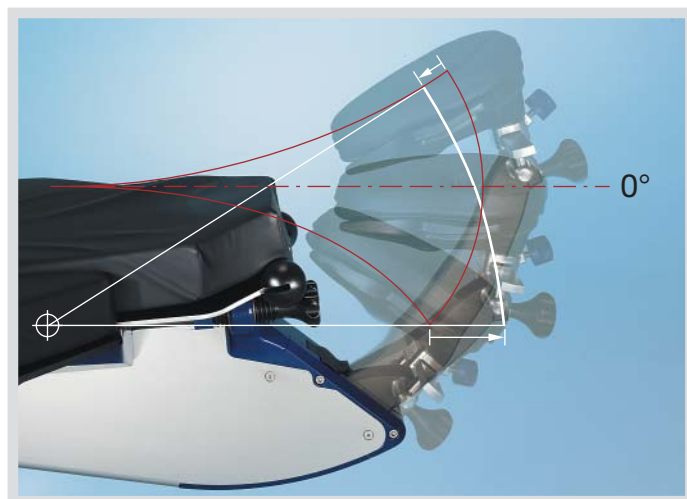

*The red line shows the natural line of movement described by the new and innovative “anatomy arm” in comparison with conventional positioning along the simple arc of a circle (white line).*



## ERGONOMICS MEET EFFICIENCY COMFORT IN EVERY PHASE OF THE OPERATION

### **The ideal working position for both patient and surgeon:**

The reduced height of the ALPHASTAR TOP permits ambulatory patients to sit themselves on the table and provides a comfortable working environment for the surgeon while seated. The table moves into the desired position under electronic control, and that position can be committed to electronic memory. The head is positioned to relieve strain on the cervical spine, using the corded hand control, while fine adjustment is made manually. Pressing just a single button returns the table to the pre-programmed 0-position.



*The ideal head position is set, using motor power, with the corded hand control, while the screw is used for fine adjustment*

## HEAD POSITIONING THAT MAKES SENSE PERFECT SUPPORT DURING EVERY PHASE



*Positioning exactly as desired, easily set up with the corded hand control*



*Motor-powered head positioning with the patented "anatomy arm" to relieve strain on the cervical spine*



## OPEN TO EVERY OPTION ACCESSORIES AND LEG PLATES

**Multifunctional:** The modular design of the table top is the basis for the great adaptability to specific surgical disciplines and patient statures. The simple “Easy Click” function permits easy interchanging of the modules. The “reverse mode”, in which the patient position is reversed 180° head-to-foot,

permits additional positioning and surgical possibilities. There are no crossbars in the operating table, neither in the head plate, back plate, seat plate nor the leg plates, eliminating any interference with intraoperative fluoroscopy.



Available immediately with all models: Extra thick (80 mm) SFC padding in a multi-layer design boosts patient comfort considerably.



Back element with “anatomy arm”



Shoulder plate with detachable lateral segments



Identical mounting point geometry ensures greater flexibility when positioning the patient. Back plates can be easily interchanged for “reversed” positions.



## MOBILE AND SIMPLE TO USE AUTODRIVE AND OPERATING CONTROLS

**Trend-setting:** Even when heavily loaded, the ALPHASTAR can be moved effortlessly to any desired location. Four hydraulically actuated double swivel castors raise the operating table gently. An electric autodrive with gentle start-up and safety braking functions make for additional comfort and convenience. Special models such as the ALPHASTAR LOW with its reduced table height and the ALPHASTAR PLUS for heavy-weight patients support strain-free work.

**User-friendly:** All electrically controlled motions can be conveniently controlled with the IR remote control or the corded hand control. The optional foot switch can be attached to any of the models. All the movements can, of course, also be initiated using the override control panel at the head of the column. The panel indicates the base positions and the charge level for the operating table's batteries.



Maximum and minimum heights of the ALPHASTAR, for comfortable working, both seated and standing



All the major operating table functions (e.g. flex, reflex, 0-position or base braking) can be initiated using the corded hand control, the IR remote control or foot switches. Changes in table top settings during the operation can be effected from within the sterile area using foot switches in any of several configurations. Programming for patient orientation in the NORMAL or REVERSE mode also includes assignments for the flex/reflex functions and the 0-position. This data remains in storage even when the operating table is switched off.

The corded hand control without an "ON/OFF" switch is available as an optional alternative to the standard control elements.



# ALPHASTAR 1132.11/12/13 ACCESSORIES

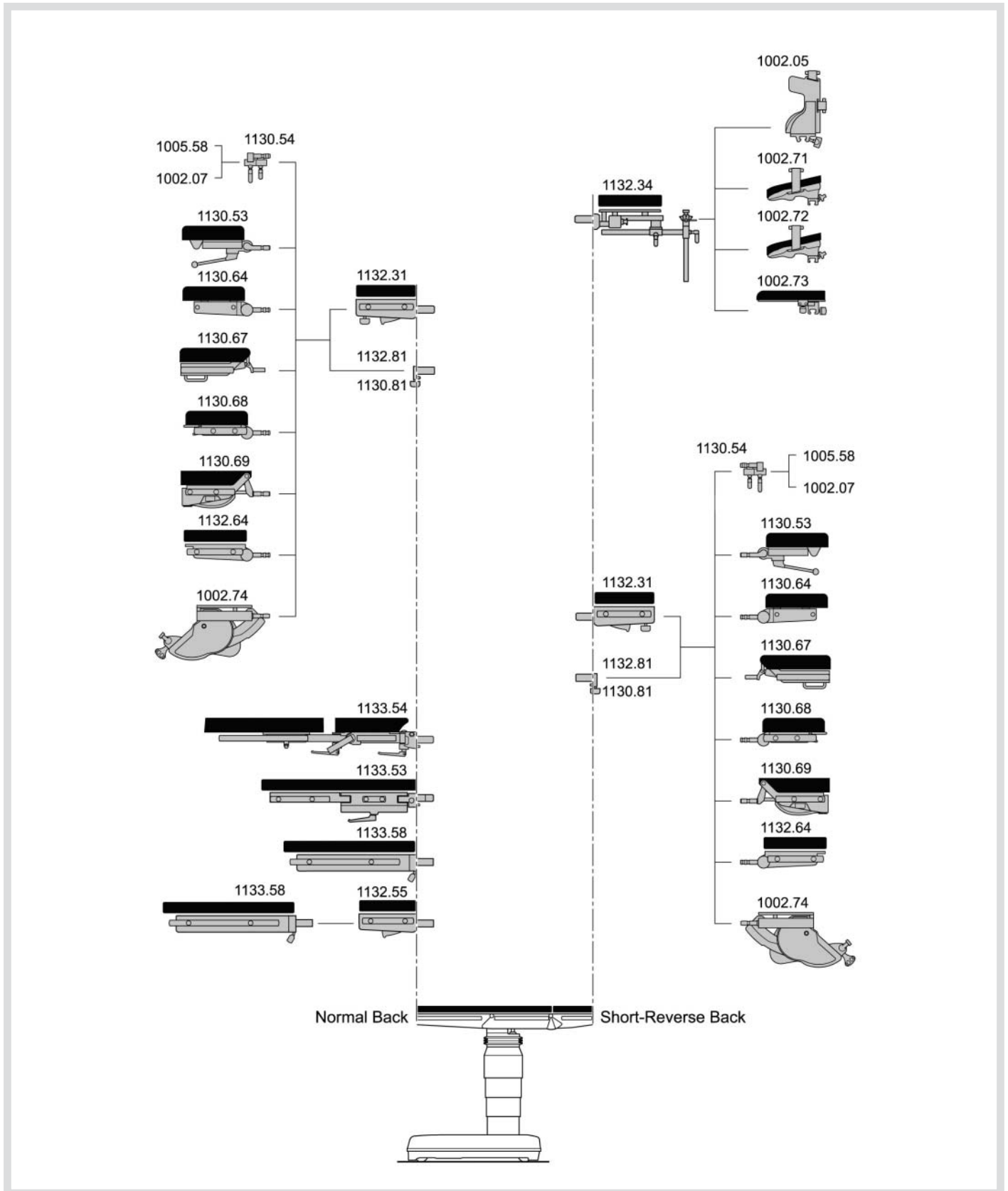

# ALPHASTAR 1132.11/12/13 ACCESSORIES

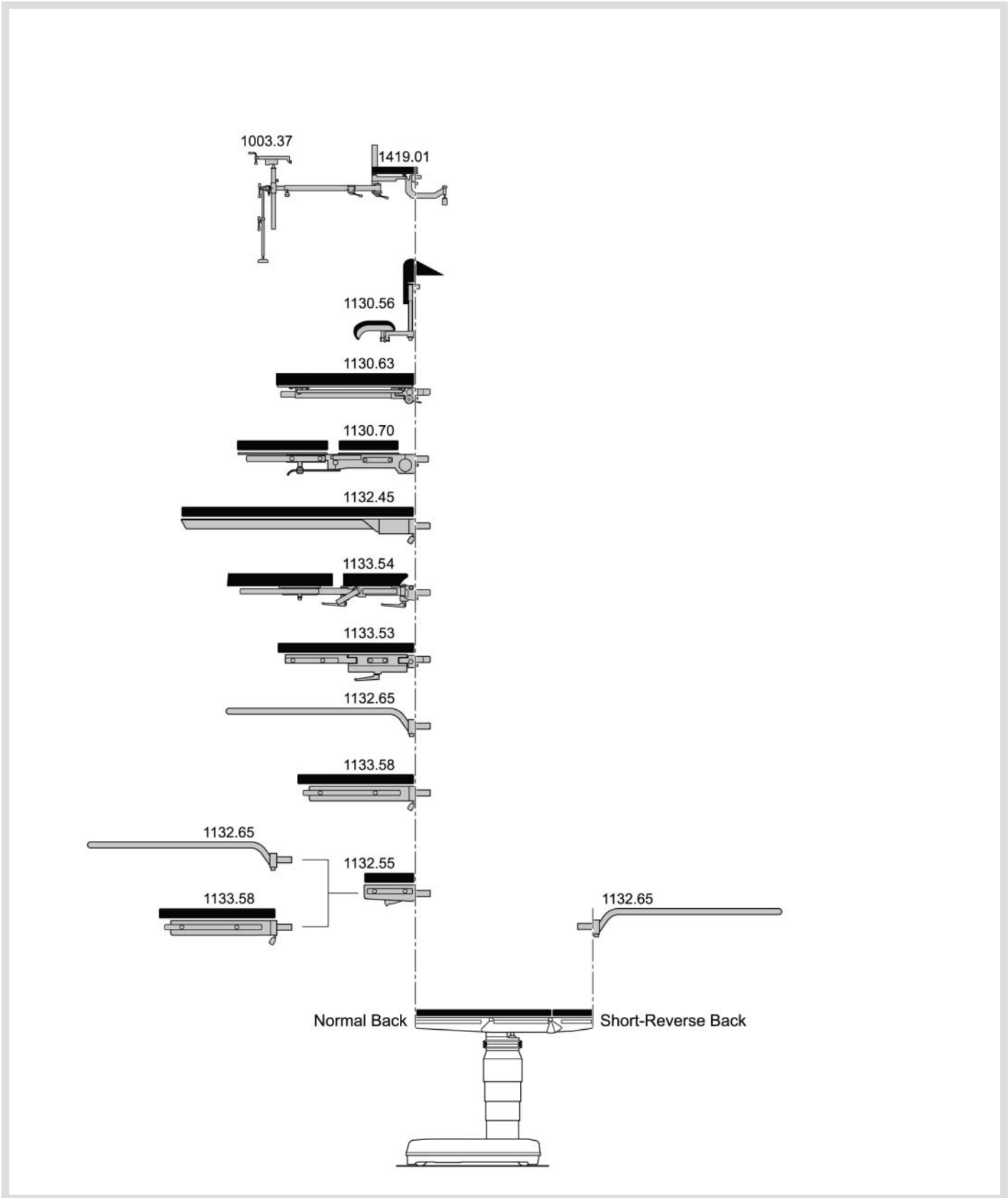

# ALPHASTAR TECHNICAL SPECIFICATIONS AND ENGINEERING FEATURES

## Adjustment options using corded hand control, IR remote control or override panel

Height without padding	
1132.11	685 – 1125 mm
1132.12	598 – 950 mm
1132.13	685 – 1070 mm
Trendelenburg	+30°/-30°
Lateral tilt, left/right	18°
NORMAL back plate	+68°/-25°
Short REVERSE back plate	+80°/-105°
Leg plates	+80°/-105°
0-position (resetting adjustments such as Trendelenburg/ reverse Trendelenburg, lateral tilt, back plate and leg plates)	
Base braking (lock/unlock)	
Patient orientation (NORMAL/REVERSE)	
Autodrive in the base	
(Equipment option in conjunction with the corded hand control)	

## Technical information

Max. patient weight	
1132.11/12	270 kg
1132.13	450 kg
Operating table weight	300 kg
Complies with CE requirements as per 93/42 EEC Medical Device Directive	

## Dimensions

Length without head plate and extension plates	1300 mm
Length with head plate and extension plates	2095 mm
Width	520 mm
Width across side rails	590 mm

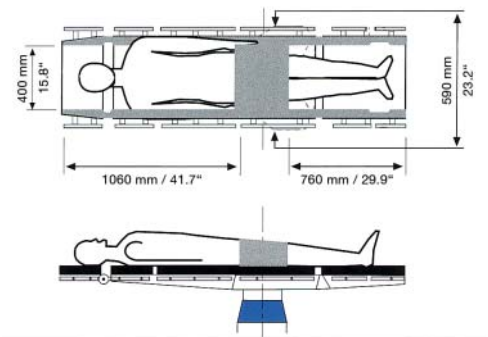
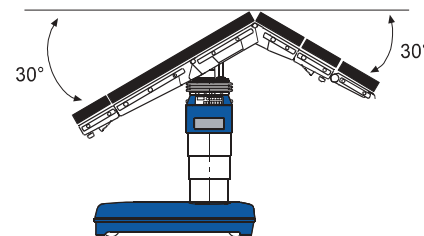
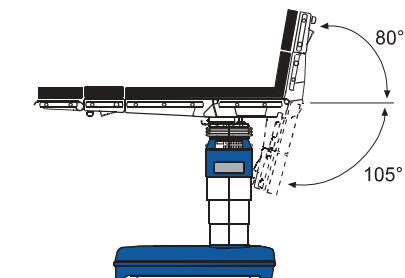
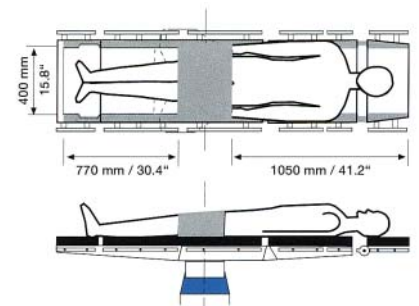
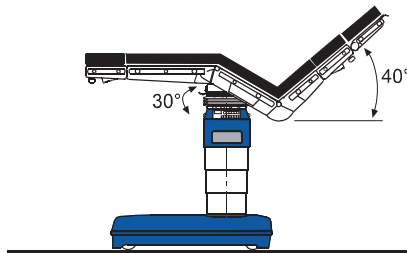
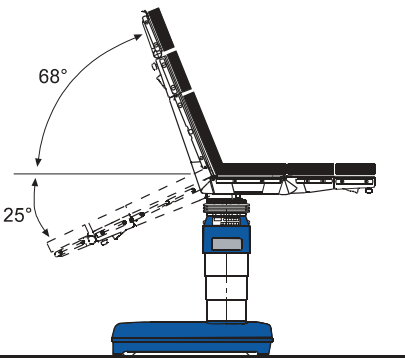
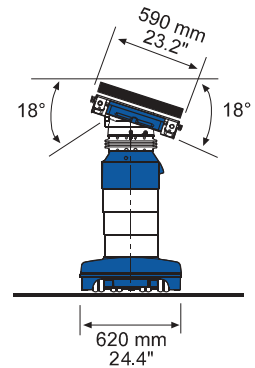
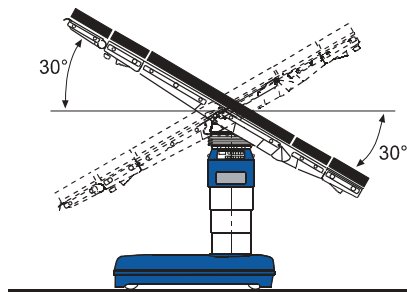
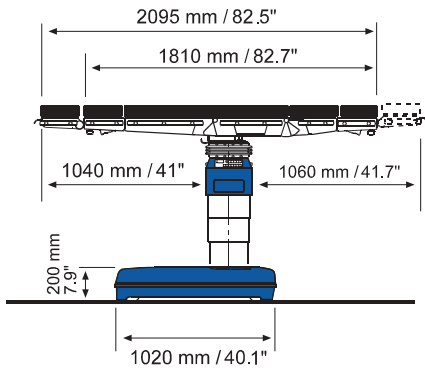

# ALPHASTAR TOP TECHNICAL SPECIFICATIONS AND ENGINEERING FEATURES

## Adjustment options using corded hand control, IR remote control or override panel

Height without padding	600 – 950 mm
Trendelenburg	+30°/-30°
Head rest	+25°/-35°
Fine adjustment, head rest longitudinal extension	50 mm
Back plate up	85°
Back plate, longitudinal extension	100 mm
Leg plate down	-25°

## Technical information

Max. patient weight	
with the “lock” function	225 kg
with the “unlock” function	135 kg
Operating table weight	360 kg
Complies with CE requirements as per 93/42 EEC Medical Device Directive	

## Dimensions

Length without head rest	2070 mm
Width	650 mm
Width across side rails	710 mm

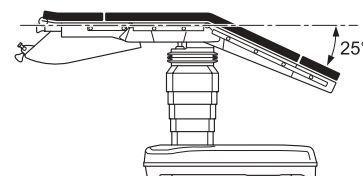
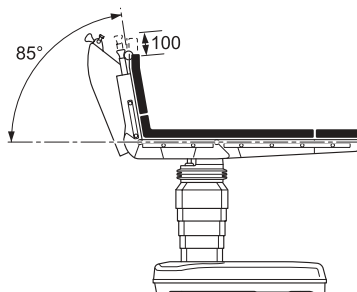
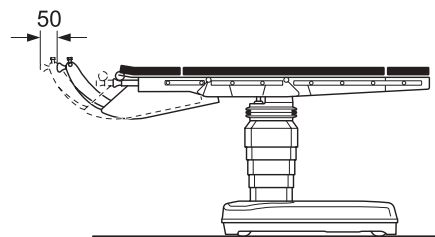
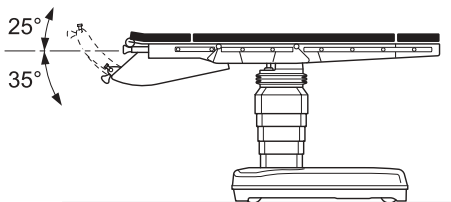
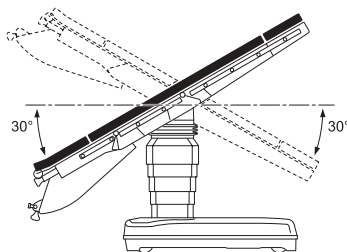
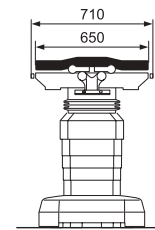
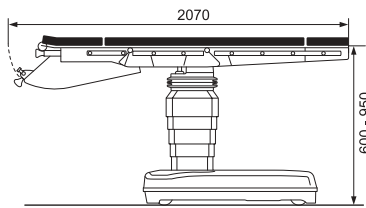

## ALPHASTAR

### GENERAL ENGINEERING FEATURES:

- Rechargeable battery and mains operation (see electrical specifications)
- Initiation of the electrohydraulic autodrives and adjustment functions using the corded hand control or IR remote control
- Stable base construction with four double swivel castors for easy movement and manoeuvring (locking with the control units)
- Additional foot switches optional for all models
- Base cover and cover for the override panel made of GFR composite plastic resistant to impact, breakage and disinfectants. Coloured in the base shade and coated with an additional scratch-resistant enamel.
- Column casing made of chrome-nickel steel
- Seat and back plate supporting arms with disinfectant- and scratch-resistant enamel finish
- Joint covers and side rails made of chrome-nickel steel

### FEATURES OF THE OPERATING TABLE TOP:

- Operating table top: Subdivided into six sections with head plate (optional), two extension plates, NORMAL back plate, seat plate, short REVERSE back plate (leg plate)
- Back plates can be fitted with an extension segment to adjust table top length
- Entire table top without crossbars, to permit fluoroscopy during an operation
- With guide rails for the insertion of X-ray cassettes from either the head or foot end
- SFC padding, 80 mm thick
- Operating table tops can be employed for REVERSE patient positioning
- Patient orientation is set with the control units

### ELECTRICAL SPECIFICATIONS:

- Special-design, maintenance-free, rechargeable batteries with capacity for about a week's use in the operating room
- Electronic monitoring of the charge, with optical and acoustic indicators
- Batteries recharged from the line power supply, 100 – 240 V AC (switchable), 50 – 60 Hz, using the line cord
- Safety class II, Type B; the enclosure leakage current meets the requirements of the patient leakage current for CF conditions as per IEC 60601-1

### VARIANTS AND TABLE TOP PADDING:

1132.11A0	<b>ALPHASTAR standard version</b> with short REVERSE back plate, 270 kg max. patient weight. Mobile operating table for general surgery, modular design, electrohydraulic drive, without control units, with 80 mm SFC padding, radiotranslucent and electrically conductive. 10 x 25 mm side rails.
1132.11A2	See above (1132.11A0), but with electric autodrives in the base
1132.12A0	<b>ALPHASTAR low-height</b> version with short REVERSE back plate, 270 kg max. patient weight.
1132.12A2	See above (1132.12A0), but with electric autodrives in the base
1132.13A2	<b>ALPHASTAR PLUS</b> with short REVERSE back plate and electric autodrives in the base, 450 kg max. patient weight.

### REQUIRED ACCESSORIES:

1132.90	Corded hand control
1132.91	Infrared remote control
3110.26	Charging station (230 V)
1132.31	Extension segment
1130.67	Head plate with adjustable slope, incl. padding
1130.53	Dual-joint head rest with infinite, stabilized slope adjustment, additional lift feature

### RECOMMENDED ACCESSORIES:

1132.81	Head plate adapter to attach head plates to the lower back section of the operating table
1001.60	Arm board with ball-and-socket joint adjustment
1002.71	Horseshoe-shaped head rest, one-piece
1002.25	Arm protector
1002.57	Anaesthesia screen with two elongation tubes, 1002.59
1003.23	Radial setting clamp
1002.24	Wristlet
1001.56	Body strap, washable

### GYNAECOLOGY AND UROLOGY:

1005.86	Direct placement stirrups with gas-strut adjustment, pair, with fully adjustable calf supports
1001.65	Goepel knee crutches
1130.65	Leg plate, single-section, lightweight version, 4.7 kg, without side rails, with SFC padding
1130.70	Maquetmatic, 1 pair
1132.55	Seat plate extension for attachment to the lower back plate at the operating table, with guide rails for X-ray cassettes and TUR drainage set
1003.45	TUR drainage set consisting of CrNi steel frame, plastic bowl with CrNi strainer and discharge hose
1003.46	Mobile frame for TUR drainage set, made of CrNi steel, with water collection bucket
1009.81	Foot switch with these functions: Table top up/down, Trendelenburg/reverse Trendelenburg adjustment, third adjustment (to be specified)

### NEUROSURGERY:

1130.54	Connecting bracket for head rest
1132.81	Head plate adapter
1005.29	Basic unit
1005.35	Skull clamp
1005.23	Crossbar attachment for positioning the seated patient

## ALPHASTAR TOP

### GENERAL ENGINEERING FEATURES:

- Rechargeable battery and mains operation (see electrical specifications)
- Electrohydraulic drive for these functions: height; Trendelenburg/reverse Trendelenburg; back, leg and head-plate adjustment
- Stable base construction with large, double swivel castors for easy movement and manoeuvring
- Base cover made of GFR composite plastic resistant to impact, breakage and disinfectants
- Column casing made of chrome-nickel steel
- Table top supporting arms made of high-strength aluminium, with disinfectant- and scratch-resistant enamel finish

### FEATURES OF THE OPERATING TABLE TOP:

- Features of the operating table top: Subdivided into 5 sections with integrated head positioning unit (horseshoe-shaped head rest optional), back plate with longitudinal extension, seat plate and leg plate
- SFC (special foam core) padding, 80 mm thick

### ELECTRICAL SPECIFICATIONS:

- Special-design, maintenance-free, rechargeable batteries with capacity for about a week's use in the operating room
- Electronic monitoring of the charge, with optical and acoustic indicators
- Batteries recharged from the line power supply, 100 – 240 V AC (switchable), 50 – 60 Hz, using the line cord
- Safety class II, Type B; the enclosure leakage current meets the requirements of the patient leakage current for CF conditions as per IEC 60601-1

### VARIANTS AND TABLE TOP PADDING:

1132.17A2	ALPHASTAR TOP with electric drive for these functions: height; Trendelenburg/reverse Trendelenburg, back, leg and head plate adjustment. 225 kg max. patient weight with "Lock" function, 135 kg with "Unlock" function
-----------	---

### REQUIRED ACCESSORIES:

1132.90	Corded hand control
1002.71	Horseshoe-shaped head rest, one-piece
1002.25	Arm protector

### OPTIONAL ACCESSORIES

#### (OPHTHALMOLOGY, MAXILLO-FACIAL SURGERY, ENT):

1009.81	Foot switch with these functions: Table top up/down, Trendelenburg/reverse Trendelenburg adjustment, third adjustment (to be specified)
1002.72	Horseshoe-shaped head rest, two-piece (split)
1002.73	Horseshoe-shaped head rest, flat

## Subsidiaries

### Australia:

MAQUET Australia Pty Ltd  
P.O. Box 50, Bulimba  
Queensland 4171, Australia  
Phone: +61 (0) 7 33 99 33 11

### China:

MAQUET International Trading Co. Ltd.  
1988-91 Tower B, City Centre of Shanghai,  
100 Zun Yi Road, Shanghai 200051, P.R. China  
Phone: +86 (0) 21 62371957

### Finland:

MAQUET Nordic Suomi  
Vattuniemenkatu 23  
00210 Helsinki, Finland  
Phone: +358 9 682 412 60

### Hong Kong:

MAQUET Hong Kong Limited  
1105-1107 Grand Century Place I  
193 Prince Edward Road West  
Mongkok, Kowloon, Hong Kong  
Phone: +852 2393 9 511

### India:

MAQUET Medical India Pvt. Ltd.  
102, Pressman House  
70A, Nehru Road  
Vile Parle (East)  
Mumbai 400 099, India  
Phone: +91 (0) 22 56755551-2-3

### Japan:

MAQUET-Getinge K.K.  
TFT Building, East Wing 8th Floor  
3-1-22, Ariake Koto-ku  
Tokyo 135-0063, Japan  
Phone: +81 (0) 3 3599-8361

### Latin America:

MAQUET do Brasil Ltda.  
Rua Said Aiach 161, Paraíso  
04003-20 São Paulo/SP, Brasil  
Phone: +55 (0) 11 2126 2500

### Netherlands:

MAQUET Netherlands B.V.  
Rijksstraatweg 37-39  
1396 JD Baambrugge, Netherlands  
P.O. Box 2  
1390 AA Abcoude, Netherlands  
Phone: +31 (0) 294 291555

### Republic of Ireland:

MAQUET Ireland  
Unit B6  
Calmount Business Park  
Ballymount  
Dublin 12, Republic of Ireland  
Phone: +353 (0) 142 60032

### Russia:

MAQUET LLC  
17, Vorontsovskaya Street  
109147 Moscow, Russia  
Phone: +7 095 514 0055

### Singapore:

MAQUET South East Asia Pte Ltd.  
20 Bendemeer Road  
#06-01/02 Cyberhub Building  
Singapore 339914, Singapore  
Phone: +65 6 296 1992

### Slovakia:

MAQUET Medizintechnik  
Vertrieb und Service GmbH – o.z.  
Soltsovej 12  
811 08 Bratislava, Slovakia  
Phone: +421 2 50219 150

### United Kingdom:

MAQUET Ltd.  
14-15 Burford Way  
Baldon Business Park  
Sunderland  
Tyne & Wear, NE35 9PZ, United Kingdom  
Phone: +44 (0) 191 519 6200

### For local contact:

Please visit our Website  
[www.maquet.com](http://www.maquet.com)

# MAQUET

MAQUET GmbH & Co. KG  
Kehler Straße 31  
D-76437 Rastatt, Germany  
Phone: +49 (0) 7222 932-0  
Fax: +49 (0) 7222 932-571  
Service-Hotline: +49 (0) 7222 932-745  
[info.sales@maquet.de](mailto:info.sales@maquet.de)  
[www.maquet.com](http://www.maquet.com)

GETINGE

GETINGE GROUP is a leading global provider of equipment and systems that contribute to quality enhancement and cost efficiency within healthcare and life sciences. Equipment, services and technologies are supplied under the brands ARJO for patient hygiene, patient handling and wound care, GETINGE for infection control and prevention within healthcare and life science and MAQUET for Surgical Workplaces, Cardiopulmonary and Critical Care.